



SYSTEM H5
SIDEWINDER





VISION ACCOMPLISHED

From humble beginnings in our founder's garage over 40 years ago, Hawke has become a world leader in sport optics. Headquartered in the United Kingdom with a presence in over 60 countries and expanding to the United States in 2007, we are still a family-run business today.

Our mission is to produce the finest precision optics available anywhere in the world. We do this with relentless dedication to quality and innovation. We start with the finest materials and the highest quality standards. Precision designs result in products with outstanding performance in the field.

At Hawke our products represent our founder's passion for placing a premium on quality, a dedication to value and devotion to customer service.

Once you've experienced Hawke you'll understand what we mean when we say Vision Accomplished.

SIDEWINDER SYSTEM H5

For over a decade, the Sidewinder has been a byword for performance and reliability. Created with almost every conceivable option, the Sidewinder is seen as a multi-discipline optic with a wide range of uses. The result: our most popular riflescope ever.

Be it winning target competitions on the world stage, or trekking on a hunt through the plains of Africa, the Sidewinder feels perfectly at home and is totally adaptable to suit your shooting discipline.

This all new Sidewinder takes things to another level. Redesigned from the ground up, with our H5 Optics, the all new Sidewinder is a huge upgrade. Lighter, stronger, 4 inch eye relief, premium crown glass, improved illumination and a new locking turret system with witness window. 10 variations available, including FFP and SFP.

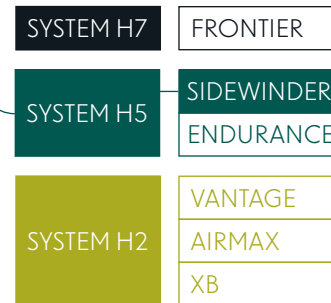

Hawke's new System H5 optics boast a stunning 24° ultra-wide field of view with generous 100mm eye relief. This projects a high volume 'eye-box' image that passes through the scope, bringing you closer to the action than ever before.

Improved sharpness and clarity provides incredible accuracy and unrivalled down range performance. 18 layer multiple lens coatings allow for the intense light transmission required from top optical devices.

High grade, low dispersion crown glass is used throughout to create crisp first and second focal plane optical systems that have minimal field curvature and distortion.

SIDEMINDER 30 SF

SIDEMINDER 30 SF

SPECIAL FEATURES SIDEWINDER

EXPOSED, LOCKING TURRETS WITH WITNESS WINDOW

The Sidewinder's new push/pull locking elevation turret has a 'witness window' to ensure you always know which revolution your turret is on. This is especially useful for shooters who like to dial out to longer distances and need to keep track of how many revolutions have been made. As the elevation turret passes through each full rotation, the internal scale travels up or down and can be seen at a glance. No more uncertainty or lengthy click counting needed to get back to your original zero. The turrets are either $\frac{1}{10}$ MRAD or $\frac{1}{4}$ MOA and are easily reset to 0 after sighting in.



SIDE FOCUS WITH REMOVABLE INDEX-MATCHED SIDE WHEEL

An all new index-matched side wheel (included*) makes parallax adjustment more accurate than ever before. The oversized wheel locks into place ensuring a solid and more responsive rotation. This allows for the finest focus adjustment and perfect parallax error correction.

All models are focus adjustable from 9 metres up to infinity.

*2.5"/65mm included with 17140/17150. 4"/100mm included with other models.





ZOOM MAGNIFICATION THROW LEVER

All models are supplied with a removable throw lever that allows you to instantly adjust the magnification. This is vital in the field when reaction speed is crucial or weather conditions demand you to be wearing gloves.



FAST FOCUS EYEBELL WITH LOCK RING

Set it and forget it. Quickly achieve sharp reticle focus and then lock it down to avoid accidentally adjusting dioptre settings. This simple yet essential feature is something that is omitted on far too many riflescopes and can lead to focusing issues when it comes to pulling the trigger. By locking the ocular focus in place you can be sure that when the time comes you have one more thing in check and the confidence you will be on target.

OPTICAL FEATURES SYSTEM H5

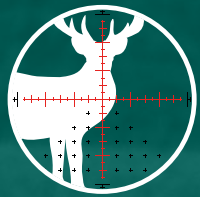

FIRST FOCAL PLANE (FFP) AND SECOND FOCAL PLANE (SFP)

Sidewinder offers a selection of first and second focal plane optical systems. FFP models ensure your holdover aim points stay true no matter what magnification you are using – when the magnification is increased, the reticle increases in size along with the target image.

SFP models see the reticle stay the same size to your eye during magnification adjustment, meaning you maintain a finer reticle for target accuracy when on highest magnification setting.

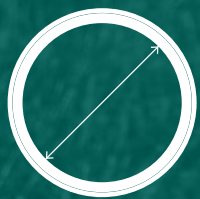

ULTRA-WIDE ANGLE (24°) FIELD OF VIEW

Up to 20% wider, which is the key to success for rapid target acquisition and ease of use.



100mm EYE RELIEF

Provides a generous and comfortable eye relief at all magnifications, ensuring a safe viewing distance from the rifle scope, ideal for high recoil and magnum calibres.

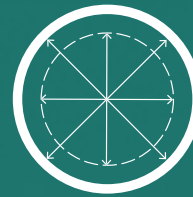

HIGH VOLUME 'EYE-BOX'

A thin FOV edge and larger eye-box creates an easy to achieve full image for faster more comfortable targeting.



MINIMAL FIELD CURVATURE

The high-end optical system reduces the effect of curvature and blurriness seen at the edge of view.

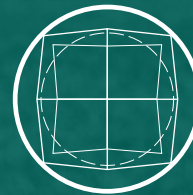

DISTORTION FREE

Crown glass is used to remove radial distortion, creating a flatter field of view and removal of barrel distortion, to ensure optimum quality of image.



FULLY MULTI-COATED

18 layers, treated with multiple lens coatings including ion-assisted coating allows for highest light transmission and a high level of abrasion resistance, exceeding military standards for hardness and durability.

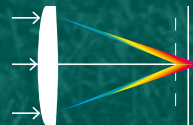

LOW DISPERSION CROWN GLASS

Crown glass is a high-quality optical glass used in precision lenses for a low dispersion property that combats chromatic aberration. It is also lead free resulting in lighter weight optical systems.



MECHANICAL FEATURES SIDEWINDER

■ 30mm MONO-TUBE CHASSIS

We use 6061-T6 aluminium with a hard heat treatment for superior strength. It remains resistant to corrosion even when the surface is scratched. The aircraft-grade, aluminium chassis creates a stronger and lighter riflescope.

■ DUAL LED RETICLE ILLUMINATION

The new custom designed dual LED illumination system delivers intense brightness to ensure the reticle can be seen in bright daylight. There are six levels of brightness with off settings between each level. The lowest setting prevents low-light blindness from overpowered illumination.

■ SUPPLIED WITH SUNSHADE

The supplied 100mm sunshade screws effortlessly into the objective end of the riflescope and keeps out unwanted glare during bright days, or when the sun is low.

■ FLIP-UP COVER AND ACCESSORY COMPATIBLE

Compatible with Hawke's exclusive Professional Flip-Up Covers, allowing protection for your lenses no matter the conditions. Additional side wheels are available in two sizes offering great flexibility (100mm and 65mm).



■ WATERPROOF, FOG PROOF & SHOCKPROOF

Fully sealed for waterproofing and purged with nitrogen gas to fog proof. Assembled in a climatically controlled environment. Heavy duty recoil proof lens assemblies utilised throughout, with recoil testing to 1000G.



RETICLES SIDEWINDER

Accurate, multiple aimpoint reticles ensure you are ready for any situation. The all-new Sidewinder series benefits from laser etched glass reticles that deliver precise and detailed aimpoints for holdover, ranging and windage corrections. A selection of first and second focal plane optical systems stretch the boundary of what is possible in these long range optics of choice.

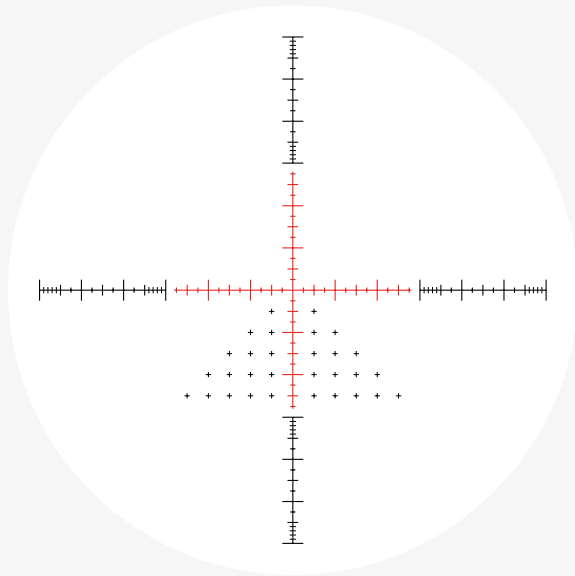

FFP HALF MIL

The FFP Half Mil reticle was developed specifically for first focal plane optical systems and based around the common principles of mil spaced reticles. With half mil spaced markings out beyond 5 mil in all directions, the FFP Half Mil is a versatile reticle that provides aim points no matter how extreme the conditions.

A series of crosses etched on the lower section of the reticle make for extra windage aimpoints and act to give an easy quick-glance method of counting which mil spacing you're aiming with. Outer posts are segmented into mil spacing and 0.2 mil spacings, so can be used for bracketing and range finding.

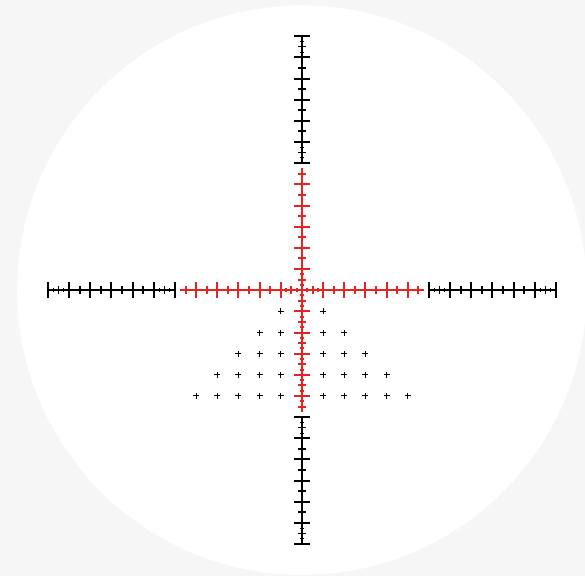

FFP MOA

The FFP MOA reticle has been designed for first focal plane shooting where MOA spaced aimpoints are preferred. MOA reticle subtensions very closely resemble an imperial scale of 1 MOA equal to 1 inch at 100 yards.

With vertical subtensions every 1 MOA, this gives closer aimpoints than the FFP Half Mil version, producing an even more accurate reticle.

The crosses etched on the lower half double up as windage aimpoints and a counting method, with each cross positioned 4 MOA apart.

The outer non-illuminated posts are segmented into MOA spacing and can be used for extreme holdover, or bracketing for distance calculations.

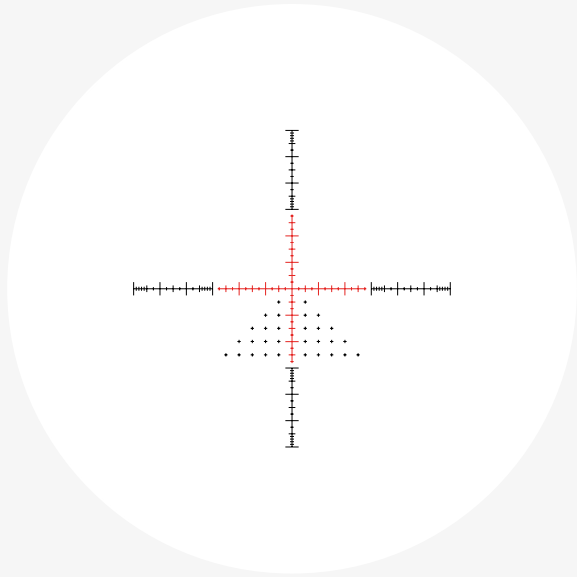

10x HALF MIL

Accurate mil spacing on 10x magnification. With half mil spaced markings out beyond 5 mil in all directions, the 10x Half Mil is a versatile reticle that provides aim points no matter how extreme the conditions.

A series of crosses etched on the lower section of the reticle make for extra windage aimpoints and act to give an easy quick-glance method of counting which mil spacing you're aiming with. Outer posts are segmented into half mil spacing and 0.2 mil spacings, so can be used for bracketing and rangefinding.

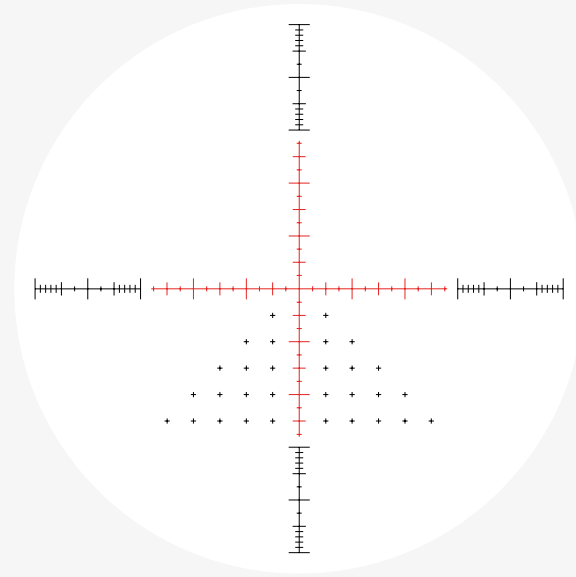

20x HALF MIL

The 20x Half Mil reticle is similar to the 10x Half Mil reticle, but is 'true' mil spacing when on the higher 20x magnification. This makes the reticle appear larger when viewed through the riflescope, but still maintains a fine reticle thickness to ensure lethal accuracy down range.

The extended reticle stretches out towards the edge of the view and so helps to give holdover aimpoints for targeting at extreme range.

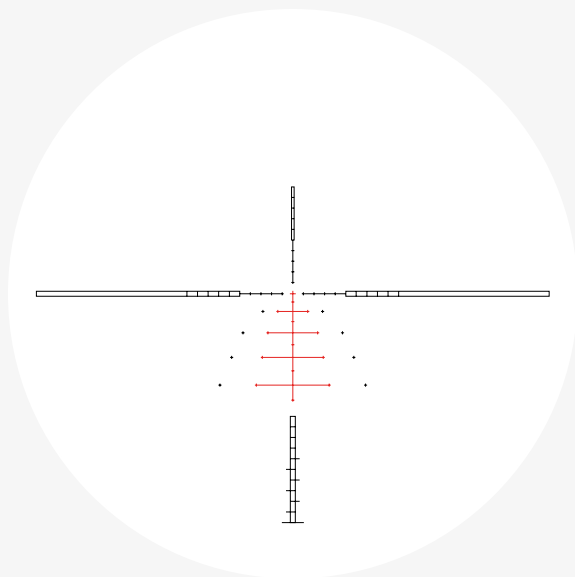

SR PRO II

Working with your bullet's trajectory the SR Pro II reticle, exclusively from Hawke, is guaranteed to provide usable aim points whatever your caliber. The reticle features an illuminated central aim point, holdover aim points with windage bars and dots, hollow posts that don't obstruct your view and range finding brackets.

The holdover aim points on the lower post of the reticle are designed with gaps increasing in size. This more closely represents the fall of a bullet's trajectory; the further the bullet travels, the faster the bullet falls.

When on 8x magnification, the hollow bars at the edge of the reticle are divided into segments that each represent 3.6 inches at 100 yards (this is equal to 100mm at 100m, also known as 1 MRAD).

further information available at hawkeoptics.com



SPECIFICATIONS SIDEWINDER

Code	Model	Reticle	Illumination		Eye Relief mm	Field of View degrees	Parallax Focus m	Exit Pupil mm	Click Value	Turret Clicks max.
			levels	colour						
17 140	4.5-14x44 SF	10x Half Mil	6	Red	102	5.4-1.7	9-∞	9.8-3.1	1/10 MRAD	28 MRAD
17 150	6.5-20x44 SF	20x Half Mil	6	Red	102	3.7-1.2	9-∞	6.8-2.2	1/10 MRAD	28 MRAD
17 250	4-16x50 SF	10x Half Mil	6	Red	102	6.1-1.5	9-∞	12.5-3.1	1/10 MRAD	26 MRAD
17 251	4-16x50 SF	SR Pro II	6	Red	102	6.1-1.5	9-∞	12.5-3.1	1/10 MRAD	26 MRAD
17 260	6-24x56 SF	20x Half Mil	6	Red	102	4.1-1	9-∞	9.3-2.3	1/10 MRAD	20 MRAD
17 261	6-24x56 SF	SR Pro II	6	Red	102	4.1-1	9-∞	9.3-2.3	1/10 MRAD	20 MRAD
17 270	8-32x56 SF	20x Half Mil	6	Red	102	3-0.7	9-∞	7-1.8	1/10 MRAD	16 MRAD
17 271	8-32x56 SF	SR Pro II	6	Red	102	3-0.7	9-∞	7-1.8	1/10 MRAD	16 MRAD
17 450	4-16x50 SF	FFP Half Mil	6	Red	102	6.1-1.5	9-∞	12.5-3.1	1/10 MRAD	26 MRAD
17 451	4-16x50 SF	FFP MOA	6	Red	102	6.1-1.5	9-∞	12.5-3.1	1/4 MOA	89 MOA
17 460	6-24x56 SF	FFP Half Mil	6	Red	102	4.1-1	9-∞	9.3-2.3	1/10 MRAD	20 MRAD
17 461	6-24x56 SF	FFP MOA	6	Red	102	4.1-1	9-∞	9.3-2.3	1/4 MOA	69 MOA

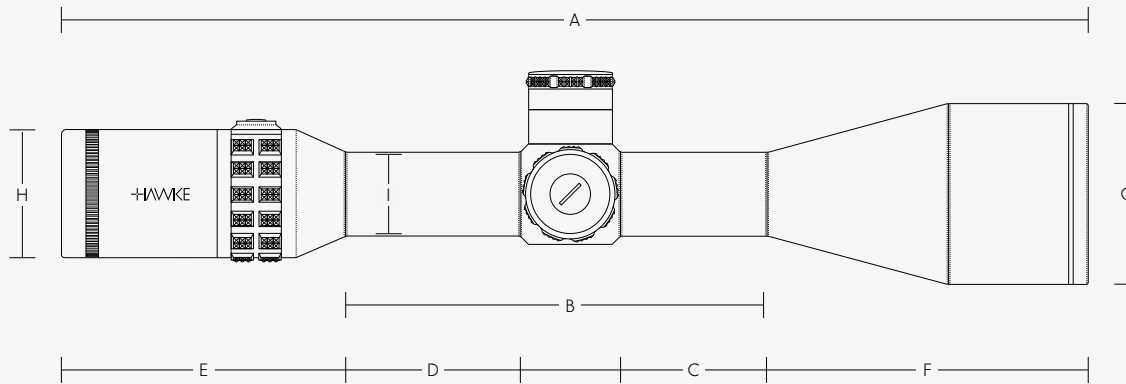

Code	Weight	A	B	C	D	E	F	G	H	I
	g	mm	mm	mm	mm	mm	mm	mm	mm	mm
17 140	680	339	143	47	57	99	97	51	46	30
17 150	680	339	143	47	57	99	97	51	46	30
17 250	725	339	142	41	62	99	98	57	46	30
17 251	725	339	142	41	62	99	98	57	46	30
17 260	775	363	152	51	62	99	112	64	46	30
17 261	775	363	152	51	62	99	112	64	46	30
17 270	775	394	160	59	62	99	135	64	46	30
17 271	775	394	160	59	62	99	135	64	46	30
17 450	725	339	142	41	62	99	98	57	46	30
17 451	725	339	142	41	62	99	98	57	46	30
17 460	775	363	152	51	62	99	112	64	46	30
17 461	775	363	152	51	62	99	112	64	46	30

FEATURE COMPARISON SIDEWINDER

Code(s)	Model	Tube Diameter		Focal Plane		Parallax Adjustment			Illuminated Reticle	Wide Angle	Turret Style				Supplied with			Locking Ocular	Fig.
		30mm	1 Inch	First	Second	Side Focus	Adjustable Objective	Fixed			Exposed, Zero Lock 'n' Stop	Exposed, Locking	Capped, Low-Profile	Capped, Target	Sunshade	Flip-up Covers	Side Wheel		
17 140	4.5-14x44 SF	●	-	-	●	●	-	-	●	●	-	●	-	-	●	○	●	●	01
17 150	6.5-20x44 SF	●	-	-	●	●	-	-	●	●	-	●	-	-	●	○	●	●	01
17 250/1	4-16x50 SF	●	-	-	●	●	-	-	●	●	-	●	-	-	●	○	●	●	02
17 260/1	6-24x56 SF	●	-	-	●	●	-	-	●	●	-	●	-	-	●	○	●	●	03
17 270/1	8-32x56 SF	●	-	-	●	●	-	-	●	●	-	●	-	-	●	○	●	●	04
17 450/1	4-16x50 SF	●	-	●	-	●	-	-	●	●	-	●	-	-	●	○	●	●	02
17 460/1	6-24x56 SF	●	-	●	-	●	-	-	●	●	-	●	-	-	●	○	●	●	03

● Included ○ Optional - N/A



01



02



03



04







INCLUDED ACCESSORIES SIDEWINDER



65mm Side Wheel
44mm objective models only



100mm Side Wheel
50mm/56mm objective models only



100mm Sunshade



Elasticated Lens Covers



Zoom Lever

COMPATIBLE ACCESSORIES SIDEWINDER



Objective Pro Flip-Up Cover



Ocular Pro Flip-Up Cover



Honeycomb Sunshade







Hawke reserves the right to make design and/or material modifications without prior notice. Hawke products are covered and/or licensed by one or more registered designs, patents or are patent pending – visit www.hawkeoptics.com/ip. Registered trademarks: Hawke, the Hawke logo, Frontier, Endurance, Vantage, Sidewinder, Airmax and Nature-Trek. This publication may not be reprinted or otherwise reproduced without the expressed written consent of Hawke. All rights reserved. Errors and omissions excepted.



99032

GLOBAL

www.hawkeoptics.com

